

NEW SOUTH WALES / HEAD OFFICE
2 Wonderland Drive EASTERN CREEK NSW 2766
PH : 02-8805-4000 FAX : 02-8805-4248

QUEENSLAND
23 Terrace Place MURARRIE QLD 4172
PH : 07-3908-9000 FAX : 07-3399-4179

VICTORIA
3 John Deere Court, Parkwest Estate DERRIMUT VIC 3030
PH : 03-8369-0900 FAX : 03-9931-0677

SOUTH AUSTRALIA
91 Transport Avenue NETLEY SA 5037
PH : 08-8238-0200 FAX : 08-8238-0299

WESTERN AUSTRALIA
Unit 1/1A 2 Business Way Malaga
PO Box 1724 Malaga WA 6944
PH : 08-9249-3721 FAX : 08-9249-1300

Customer Information Centre is available 7 days
from 7AM-7PM on 1300 54 2273 (1300 LG CARE)
SMS Fault call 0400 660 629
www.lge.com.au

NEW ZEALAND
Unit A, 38 Highbrooke Drive, East Tamaki, 2013 New Zealand
Tel : +64 (09) 914 2444 Fax : +64 (09) 914 2441
Customer Service Helpline
0800 54 2273 (0800 LG CARE)
www.lge.co.nz



Warranty Brief

- All LG Electronics Air Conditioning Units are covered by a 5-Year Parts and Labour Warranty when used in Residential Applications. Commercial Applications attract a 2-Year Parts and Labour Warranty.*
- Air Conditioning units carry an on-site warranty.*

*Further conditions apply, see the Warranty Card for further information.



LG Electronics Changwon Facility Achieved ISO9001 Certification Under Series 9000 of International Standard Organization(ISO) Based on Quality Systems For Design & Manufacture of Air Conditioners, Hermetic Refrigeration Compressors.

Due to LG's policy of continuous improvement and innovation, some specifications may change without notice. Please check with your retailer / AC specialist prior to purchase.
© LG Electronics Australia Pty., Ltd. Printed in Korea [February, 2013]

Disclaimer

The descriptions and specifications in this brochure are relevant as at the date of publication. In the interest of product development, LG Electronics reserves the right to carry out alterations and improvements to products and specifications. Future releases of products, accessories and parts for them may differ from, and may not be compatible with current versions. As it may be difficult to determine the exact nature of a product from its depiction in this brochure. LG Electronics strongly recommends that you confirm with your retailer that the product shown or described in this brochure meets your requirements before you purchase the product.

AUS-DUT13

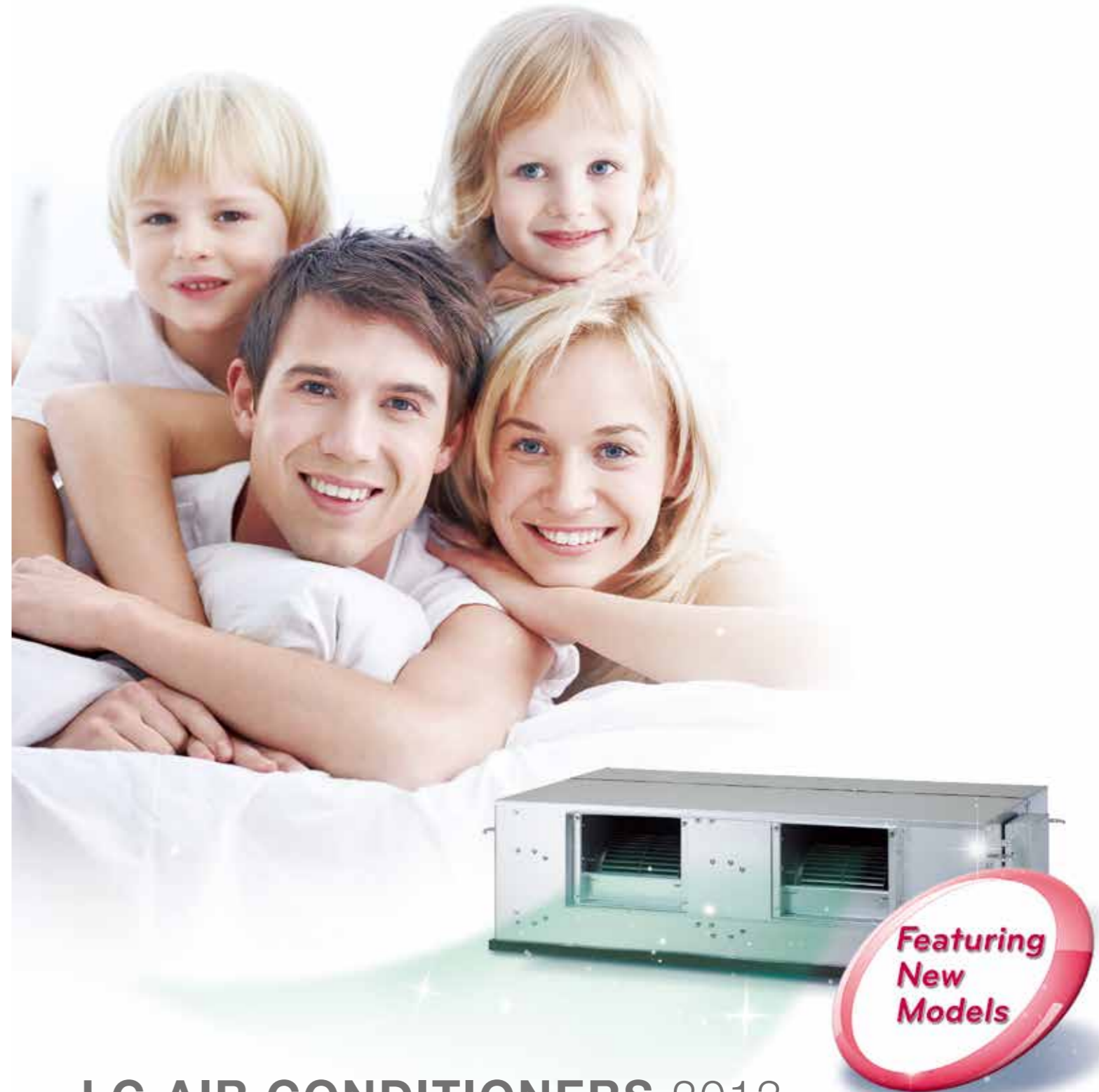

LG AIR CONDITIONERS 2013

Ducted Split System

Vitalizing You & Your Environment

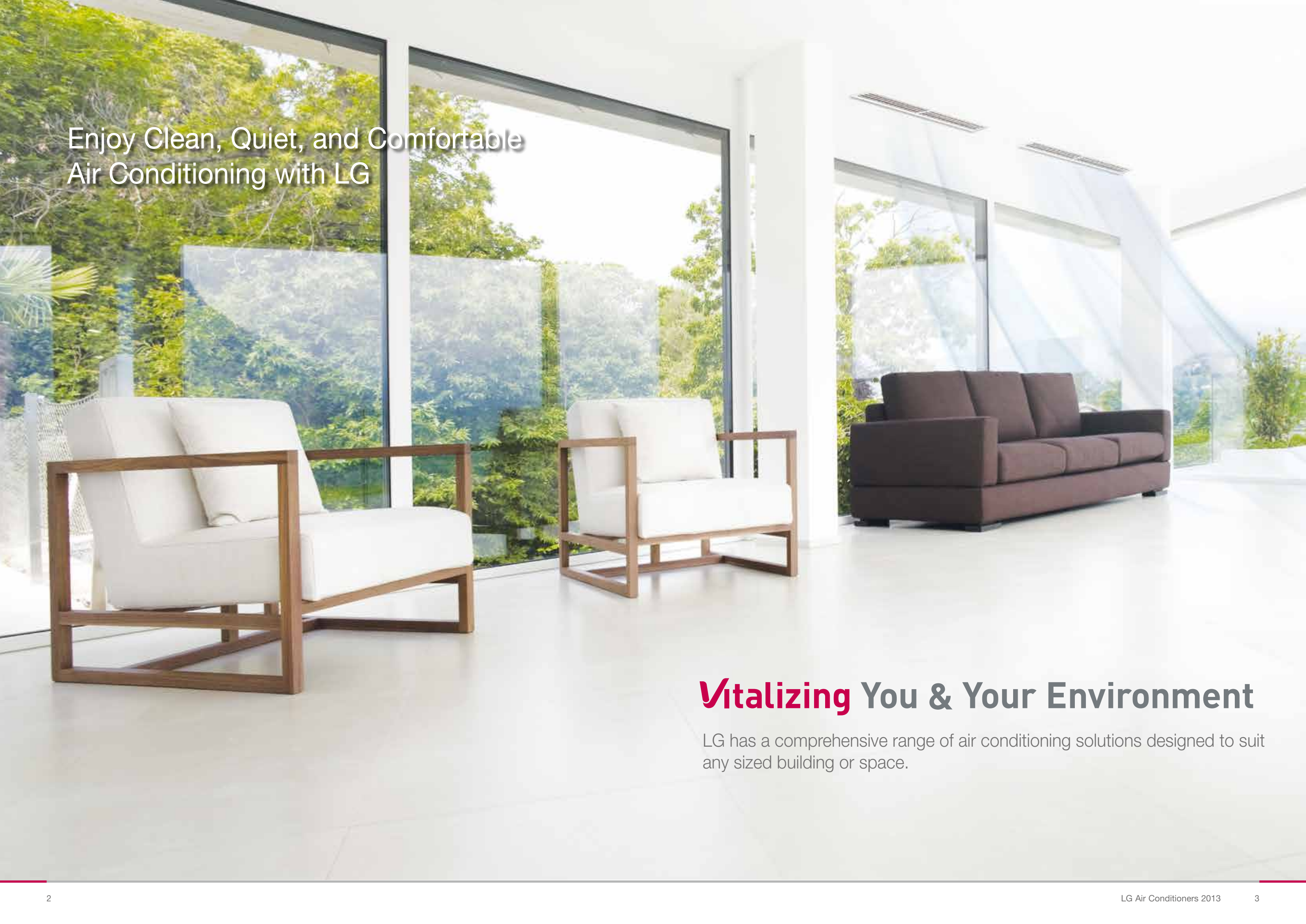

Enjoy Clean, Quiet, and Comfortable
Air Conditioning with LG

Vitalizing You & Your Environment

LG has a comprehensive range of air conditioning solutions designed to suit any sized building or space.

Ducted Split System

LG has a range of ducted air conditioners to suit any type of home or office.

Ducted Split System (Mid Static)		Model Name	Capacity(kW)
INVERTER		Indoor _ B24AWYNGMH	Rated
		Outdoor_ B24AWYUGMH	Cooling: 7.1 Heating: 8.0

Ducted Split System (High Static)		Model Name	Capacity(kW)
INVERTER		Indoor _ B30AWYN7G4	Rated
		Outdoor_ B30AWYU4G4	Cooling: 8.8 Heating: 9.2
		Indoor _ B36AWYN7G4	Cooling: 9.9
		Outdoor_ B36AWYU4G4	Heating: 11.0
		Indoor _ B42AWYN7G4	Cooling: 12.3
		Outdoor_ B42AWYU3G4	Heating: 14.1
		Indoor _ B55AWYN7G4	Cooling: 15.0
		Outdoor_ B55AWYU3G4	Heating: 17.1
		Indoor _ B70AWYN983	Rated
		Outdoor_ B70AWYUX83	Cooling: 20.0 Heating: 22.4

Outdoor Unit



Energy Efficiency

LG's advanced inverter technology reduces energy consumption and improves running costs.

User Friendly Control

LG's air conditioning solution allows users to take advantage of a hassle-free, intuitive management system via the controller



Easy Installation & Maintenance

The built-in evaporator safety tray makes the product much easier to install and maintain. Must be installed by a licensed installer.



High Reliability & Comfort

LG's latest technological innovations ensure greater overall system reliability as well as convenient benefits such as quick, stable cooling and a wider operation range than conventional systems.



Energy Efficient

The revolutionary inverter technology of LG boasts powerful yet quiet performance while minimizing energy consumption.

Energy Efficient



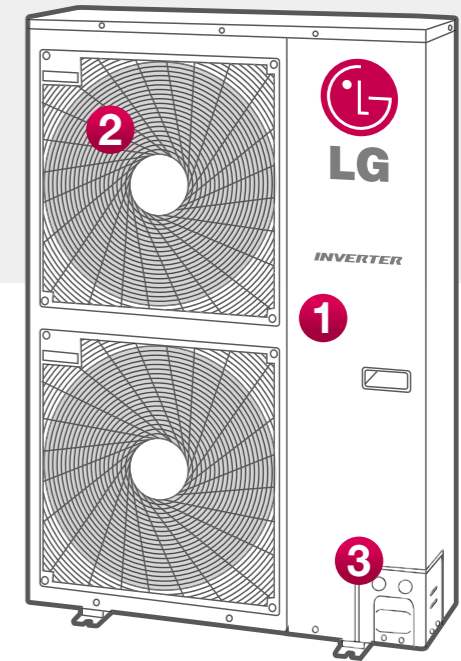

- ① Heat Exchanger
- ② BLDC Fan Motor Technology
- ③ Powerful BLDC Compressor



Powerful BLDC Compressor

LG air conditioner comes with a BLDC compressor that uses a strong neodymium magnet. Its compressor thus has improved efficiency compared with conventional AC inverters. Operation range has been expanded.

	Operation Frequency
 <p>New Concentrated Winding</p>	15 ~ 100 Hz
 <p>Conventional Distributed Winding</p>	20 ~ 100 Hz

Heat Exchanger with Wide Louver Fin

Improved heat exchanger efficiency up to *28%, applying Multi V technology.

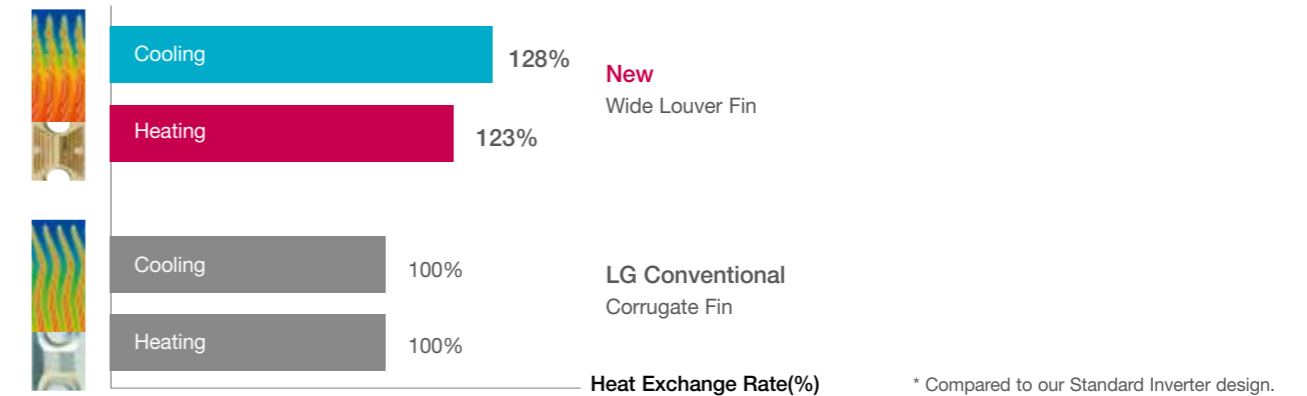

BLDC Fan Motor Technology

The LG BLDC fan motor offers additional efficiency in operating mode up to 40% at low speed, 20% at high speed compared to a LG AC motor



BLDC Fan Motor

Optimised Heat Exchanger Path

Improved cycle efficiency up to 5% with equal distribution.

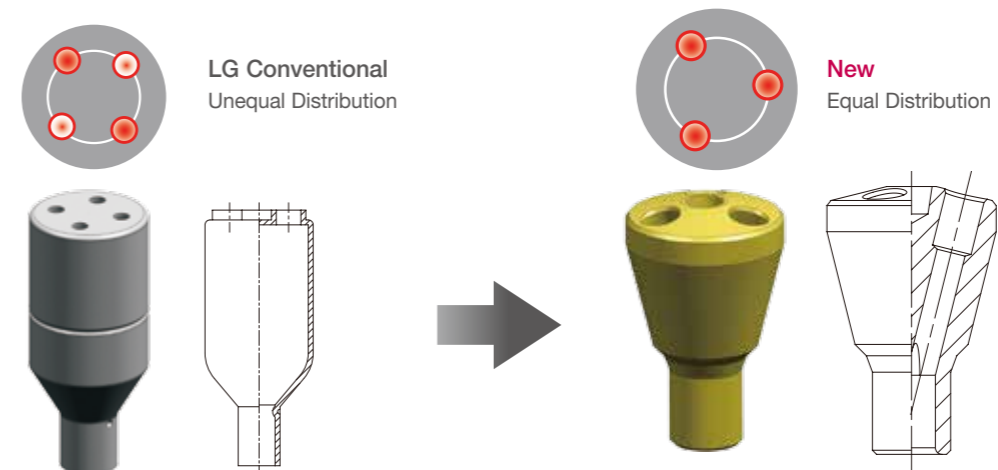

User Friendly Controller

with the LG ducted product, you have a choice of 2 convenient options:
1. Deluxe Wall Controller 2. Standard wall Controller

Deluxe Wall Controller (optional)

LG's Deluxe Backlit Wall Controller is designed to suit even the most stylish interior. The touchscreen panel allows you to control the room's temperature with simplicity and style. In homes with large floor areas, you can also have dual controls and can control up to 8 zone settings.

LCD backlit display

Enables you to easily see the control settings. The larger display allows you to program settings by simply touching the controller display.

8 Zone Control

The new controller allows you to control up to eight different areas of your home. One touch of each zone will turn it Off or On.



Touch Screen Panel

Program the controller to your desired comfort level with a touch of your finger. The new child lock setting prevents the settings from being tampered with.

PDRUCDC0 not available for B24 model.

Standard (WIDE) Wall Controller (optional)

The operator can set the timing function of the air conditioner for a period of one week.



PQRCVSLQW

LCD backlit display



Enables you to easily see the control settings.

Weekly Program

The operator can set the timer and program the air conditioner for a period of one week.

Child Lock Function

This function prevents little hands from tampering with the control buttons on the unit. All the buttons on the indoor display panel will be blocked.

Dual Wall Control (optional)

Allows you to control the unit from different locations in the home. You can install up to two controllers which communicate with each other to replicate your chosen settings.

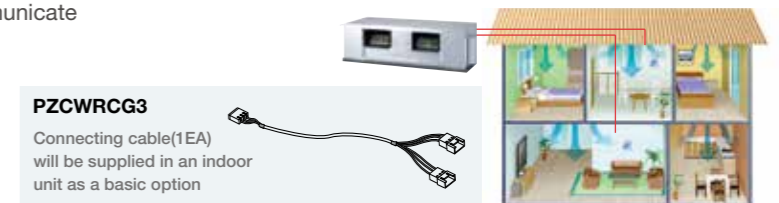

Group Control

This enables you to link several products together that can then be controlled by one control device. A connecting line is linked to each of the indoor units to enable communication. This control device can be used to control up to 16 indoor units.

Dual Thermistor Control

Dual thermistor control provides the option to control temperature by referring to either of the dual temperature sensors. With the help of the slide switch at the back of the LCD wired remote controller, selection of the desired thermistor for controlling the unit can be achieved. One thermistor is in the Indoor unit & the other one is in the LCD wired remote.

Central Controller (optional)

LG units come with advanced control options, such as the central controller, which is designed for commercial applications, where multiple units have been installed. This allows you control between 16-1024 air conditioning units, via 8 separate controllers.

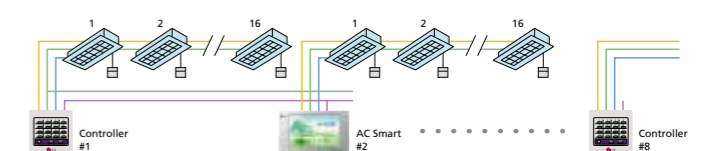

Easy Installation & Maintenance

Evaporator Safety Tray

To prevent potential damage caused by moisture, LG air conditioners have a built in auxiliary safety tray.

* Not available in B24AWYNGMH

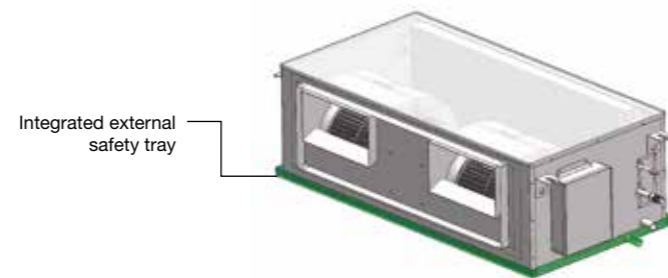

1/2 2-Split Type Duct

Fan/Motor part and Heat exchanger part can be dismantled. This enables easy movement of the door unit to its installation location by reducing the size and weight of the indoor unit (2 piece).

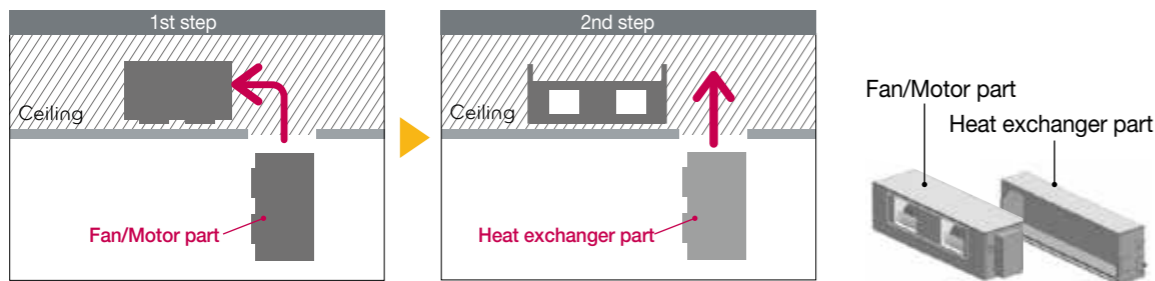

• This feature is ONLY available for B70 unit.

50m Long Distance, High Elevation Piping

Our LG concealed duct models can be installed over a long distance (Max 50m) and a High Elevation (30m), between indoor and outdoor units.

B70AWYN983: a long distance (Max. 100m) and a high elevation (30m)

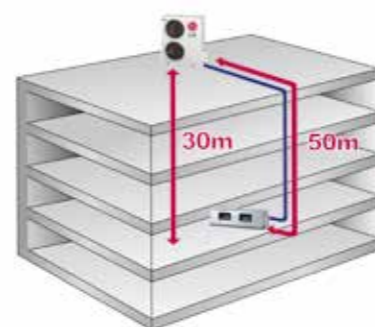

700mm Drain Pump

Auxiliary Drain Pump automatically drains water. A standard drain-head height of up to 800mm is possible, which helps create the ideal solution for water drainage.

* 700mm: 20kW, 800mm: 8.8~15kW
Refer to each model PDB for the height.

* Drain Pump available as standard for B24 model, and an optional accessory for B30-B70.

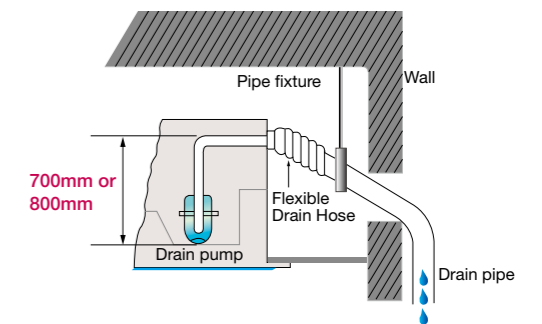

Easy Servicing

A lightweight polymer blower and housing makes air conditioning operation quieter and backup servicing more convenient. The new fan housing can be easily dismantled for convenient servicing and maintenance.

* Not available in B70AWYN983

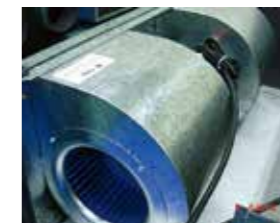

Conventional

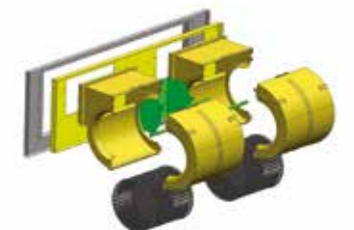

LG Fan and Housing

Size Compact Design

Compact IDU Size

Slim and Low height compact body could reduce problems during installation stage.

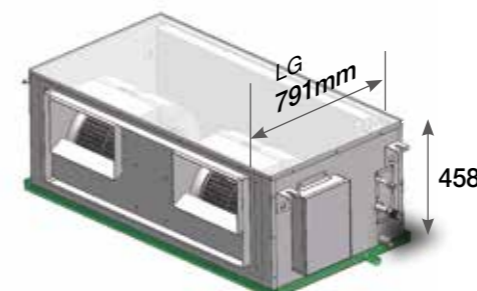

* This feature is only available for B70 unit.

Foot Print Area

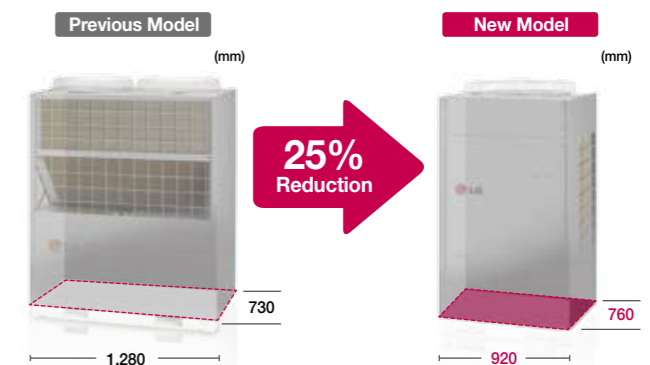

High Reliability & Comfort



Quick Operation Response

Wide Operation Range -10~48°C

Stable Operation Performance

High Reliability with Pressure Control

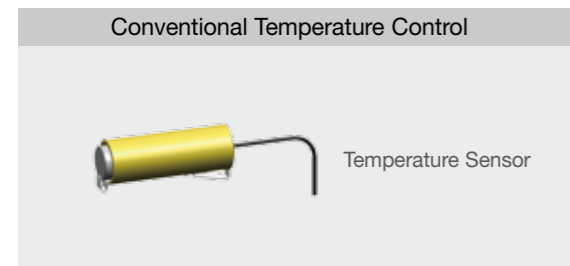

Calculate target pressure according to in/outdoor temperature, desired temperature and piping length.

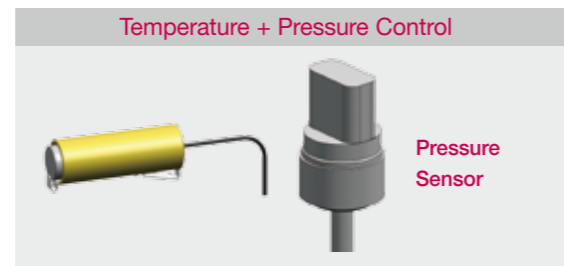

Sense and control pressure directly using a pressure sensor for faster and more exact response to load variation.

Quick Operating Response

Pressure controller takes less time to respond than the previous model improving accuracy and stability of the refrigerant system.

Wide Operating Range

- Wide Operation Range : Cooling -10~48°C

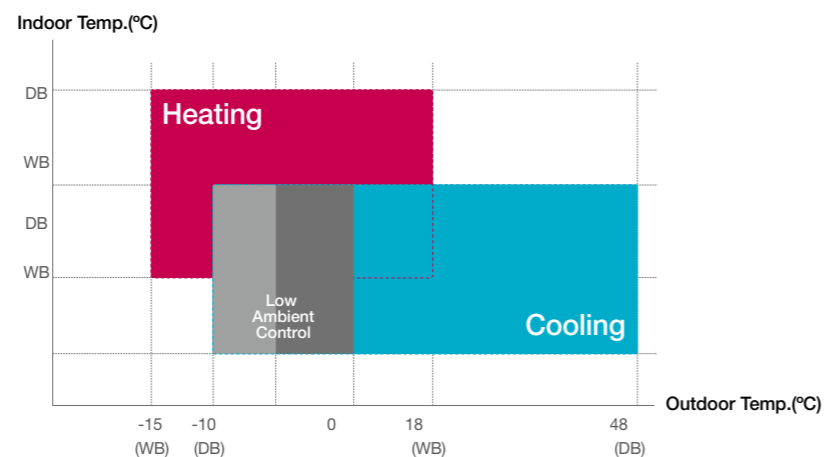

Durable Coating (GoldFin™)

GoldFin™, is an anti corrosive treatment on the surface of the heat exchanger in the outdoor unit. The treatment is designed to protect air conditioners from pollution and corrosive conditions and assists in the durability and longevity of the unit. This technology is a great solution for harsh Australian outdoor conditions.

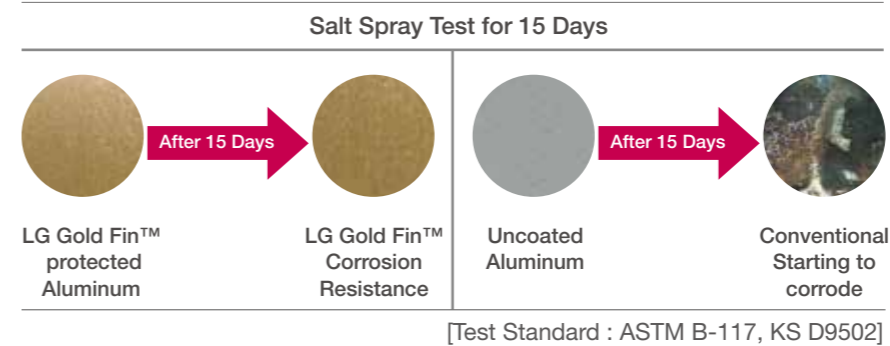

E.S.P Control (E.S.P: External Static Pressure)

Air volume can be optimised to reduce noise and comply with the system design utilising E.S.P technology. This enables you to optimise duct work installation, by maintaining capacities and sound levels as required.

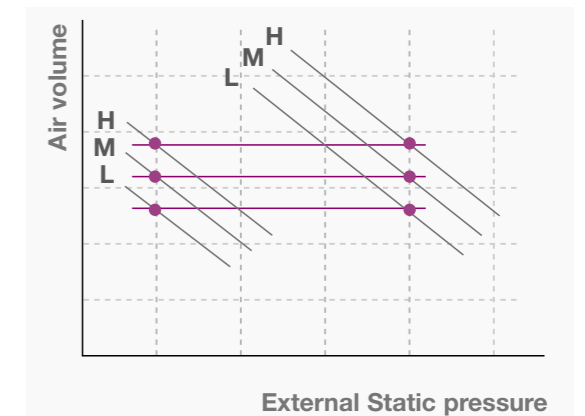

INVERTER

B24AWYNGMH



B24AWYUGMH



Indoor				B24AWYNGMH			
Capacity	Cooling	Min/Nom/Max	kW	2.84 / 7.1 / 7.81			
	Heating	Min/Nom/Max	kW	3.2 / 8.0 / 8.8			
Power Input	Cooling	Min/Nom/Max	kW	2.12			
	Heating	Min/Nom/Max	kW	2.05			
Running Current	Cooling/Heating	Nom	A	9.5/9.0			
Power Supply			V/Hz	220~240 / 1 / 50			
EER				3.35			
COP				3.9			
Piping Connection	Liquid		mm	ø 9.52			
	Gas		mm	ø 15.88			
	Drain	O.D./I.D.	mm	ø 32/26			
Air Flow Rate		High/Medium/Low	m ³ /min	25.0 / 20.0 / 14.0			
Sound Pressure	Cooling	High/Medium/Low	dBA	37/33/29			
	Heating	High/Medium/Low	dBA	37/33/30			
Sound Power	Cooling	Max	dBA	-			
Dehumidification Rate			l/h	1.36			
Dimensions	Body	WxHxD	mm	1,182 x 298 x 450			
Net Weight	Body		kg	35			
Supply Air Spigot		WxH	mm	830 X 186			
Return Air Spigot		WxH	mm	1,043 X 220			
Fan Motor Output			W	154 x 1			
External Static Pressure -pre set		Min-Max	mmAq(Pa)	2.5 ~ 10.2(25~100) -80			
Outdoor				B24AWYUGMH			
Compressor	Type			Twin Rotary			
Airflow Rate		Nom	m ³ /min	58			
Sound Pressure	Cooling	Nom	dBA	51			
	Heating	Nom	dBA	51			
Sound Power	Cooling	Max	dBA	65			
Dimensions	WxHxD		mm	950 x 834 x 330			
Net Weight			kg	63.0			
Refrigerant	Type			R410A			
	Charge		g	2,200			
	Additional Charge (after 7.5m)		g/m	40			
Operation Range (Outdoor)	Cooling	Min-Max	°C DB	-10 ~ 48			
	Heating	Min-Max	°C WB	-15 ~ 24			
Power Supply			V/Hz	220~240 / 1 / 50			
Power Supply Cable			N x mm ²	3 x 2.5			
Transmission Cable			N x mm ²	4 x 0.75			
Circuit Breaker			A	25			
Piping Length Total		Max	m	50			
Piping Elevation Difference	IDU-ODU	Max	m	30			
Piping Connection	Liquid		mm	ø 9.52			
	Gas		mm	ø 15.88			

Note : 1. Due to our policy of innovation some specifications may be changed without notification.
 2. Capacities are based on the in accordance with ASNZS3823.1.2
 Cooling: - Indoor Temperature 27°C DB / 19°C WB Heating: - Indoor Temperature 20°C DB / 15°C WB
 - Outdoor Temperature 35°C DB / 24°C WB - Outdoor Temperature 7°C DB / 6°C WB

INVERTER

**B30AWYN7G4
B36AWYN7G4**



B30AWYU4G4 B36AWYU4G4



Indoor				B30AWYN7G4				B36AWYN7G4			
Capacity	Cooling	Min/Nom/Max	kW	3.2 / 8.8 / 9.6			4.1 / 9.9 / 11.0				
	Heating	Min/Nom/Max	kW	3.7 / 9.2 / 11.0			4.4 / 11.0 / 12.1				
Power Input	Cooling	Min/Nom/Max	kW	2.85			2.9				
	Heating	Min/Nom/Max	kW	2.8			3.28				
Running Current	Cooling/Heating	Nom	A	12.7/11.3			12.4/14.5				
Power Supply			V/Hz	220~240 / 1 / 50			220~240 / 1 / 50				
EER				3.09			3.41				
COP				3.29			3.35				
Piping Connection	Liquid		mm	ø 9.52			ø 9.52				
	Gas		mm	ø 15.88			ø 15.88				
	Drain	O.D./I.D.	mm	ø 32/25			ø 32/25				
Air Flow Rate		High/Medium/Low	m ³ /min	32.0 / 26.0 / 20.0			42.0 / 36.0 / 28.0				
Sound Pressure	Cooling	High/Medium/Low	dBA	44/43/42			45/44/43				
	Heating	High/Medium/Low	dBA	44/43/42			45/44/43				
Sound Power	Cooling	Max	dBA	-			-				
Dehumidification Rate			l/h	1.8			3.0				
Dimensions	Body	WxHxD	mm	1,320 X 400 X 534			1,320 X 400 X 534				
Net Weight	Body		kg	48			48				
Supply Air Spigot		WxH	mm	840 X 287			840 X 287				
Return Air Spigot		WxH	mm	1,172 X 317			1,172 X 317				
Fan Motor Output			W	350 X 1			350 X 1				
External Static Pressure -pre set		Min-Max	mmAq(Pa)	6.35~18.4(62~200) -130			6.35~18.4(62~200)-130				
Outdoor				B30AWYU4G4				B36AWYU4G4			
Compressor	Type			Twin Rotary			Twin Rotary				
Airflow Rate		Nom	m ³ /min	58			45x2				
Sound Pressure	Cooling	Nom	dBA	48			53				
	Heating	Nom	dBA	52			54				
Sound Power	Cooling	Max	dBA	65			66				
Dimensions	WxHxD		mm	950 X 834 X 330			950 X 1,170 X 330				
Net Weight			kg	60.0			81.0				
Refrigerant	Type			R410A			R410A				
	Charge		g	2,000			2,800				
	Chargeless Piping Length (after 7.5m)		m	15			15				
Operation Range (Outdoor)	Cooling	Min-Max	°C DB	-10 ~ 48			-10 ~ 48				
	Heating	Min-Max	°C WB	-15 ~ 18			-15 ~ 18				
Power Supply			V/Hz	220~240 / 1 / 50			220~240 / 1 / 50				
Power Supply Cable			N x mm ²	3 x 2.5			3 x 5.0				
Transmission Cable			N x mm ²	4 x 1.0			4 x 1.0				
Circuit Breaker			A	25			40				
Piping Length Total		Max	m	50			50				
Piping Elevation Difference	IDU-ODU	Max	m	30			30				
Piping Connection	Liquid		mm	ø 9.52			ø 9.52				
	Gas		mm	ø 15.88			ø 15.88				

Note : 1. Due to our policy of innovation some specifications may be changed without notification.
 2. Capacities are based on the in accordance with ASNZS3823.1.2
 Cooling: - Indoor Temperature 27°C DB / 19°C WB Heating: - Indoor Temperature 20°C DB / 15°C WB
 - Outdoor Temperature 35°C DB / 24°C WB - Outdoor Temperature 7°C DB / 6°C WB

INVERTER

B42AWYN7G4
B55AWYN7G4



B42AWYU3G4 /B55AWYU3G4



Indoor				B42AWYN7G4	B55AWYN7G4
Capacity	Cooling	Min/Nom/Max	kW	4.9 / 12.3 / 14.8	6.4 / 15.0 / 17.1
	Heating	Min/Nom/Max	kW	5.6 / 14.1 / 16.9	7.0 / 17.1 / 18.0
Power Input	Cooling	Min/Nom/Max	kW	3.65	4.85
	Heating	Min/Nom/Max	kW	3.82	5.20
Running Current	Cooling/Heating	Nom	A	16.0/17.0	21.0/22.7
Power Supply			V/ø/Hz	220~240 / 1 / 50	220~240 / 1 / 50
EER				3.37	3.09
COP				3.69	3.29
Piping Connection	Liquid		mm	ø 9.52	ø 9.52
	Gas		mm	ø 15.88	ø 15.88
	Drain	O.D./I.D.	mm	ø 32/25	ø 32/25
Air Flow Rate		High/Medium/Low	m ³ /min	48.0 / 42.0 / 36.0	60.0 / 50.0 / 40.0
Sound Pressure	Cooling	High/Medium/Low	dBA	46/45/44	46/45/44
	Heating	High/Medium/Low	dBA	46/45/44	46/45/44
Sound Power	Cooling	Max	dBA	-	-
Dehumidification Rate			l/h	2.7	4.0
Dimensions	Body	WxHxD	mm	1,320 X 400 X 534	1,320 X 400 X 534
Net Weight	Body		kg	52	52
Supply Air Spigot		WxH	mm	840 X 287	840 X 287
Return Air Spigot		WxH	mm	1,172 X 317	1,172 X 317
Fan Motor Output			W	185 X 2	185 X 2
External Static Pressure-pre set		Min-Max	mmAq(Pa)	6.35~18.4(62~200)-130	6.35~18.4(62~200)-130
Outdoor				B42AWYU3G4	B55AWYU3G4
Compressor	Type			Twin Rotary	Twin Rotary
Airflow Rate		Nom	m ³ /min	55x2	55x2
Sound Pressure	Cooling	Nom	dBA	52	52
	Heating	Nom	dBA	54	54
Sound Power	Cooling	Max	dBA	67	71
Dimensions	WxHxD		mm	950 X 1,380 X 330	950 x 1,380 x 330
Net Weight			kg	92.0	92.0
Refrigerant	Type			R410A	R410A
	Charge		g	3,400	3,400
	Chargeless Piping Length (after 7.5m)		m	15	15
Operation Range (Outdoor)	Cooling	Min-Max	°C DB	-10 ~ 48	-10 ~ 48
	Heating	Min-Max	°C WB	-15 ~ 18	-15 ~ 18
Power Supply			V/ø/Hz	220~240 / 1 / 50	220~240 / 1 / 50
Power Supply Cable			N x mm ²	3 x5.0	3 x5.0
Transmission Cable			N x mm ²	4 x1.0	4 x1.0
Circuit Breaker			A	40	40
Piping Length Total		Max	m	50	50
Piping Elevation Difference	IDU-ODU	Max	m	30	30
Piping Connection	Liquid		mm	ø 9.52	ø 9.52
	Gas		mm	ø 15.88	ø 15.88

Note : 1. Due to our policy of innovation some specifications may be changed without notification.
2. Capacities are based on the in accordance with ASNZS3823.1.2
Cooling: - Indoor Temperature 27°C DB / 19°C WB Heating: - Indoor Temperature 20°C DB / 15°C WB
- Outdoor Temperature 35°C DB / 24°C WB - Outdoor Temperature 7°C DB / 6°C WB

INVERTER

B70AWYN983



B70AWYU83





Indoor				B70AWYN983
Capacity	Cooling	Min/Nom/Max	kW	12.6 / 20.0 / 25.7
	Heating	Min/Nom/Max	kW	14.1 / 22.4 / 30.0
Power Input	Cooling	Min/Nom/Max	kW	3.5/6.47/10.78
	Heating	Min/Nom/Max	kW	4.0/6.59/10.80
Running Current	Cooling/Heating	Nom	A	10.6/10.7
Power Supply			V/ø/Hz	220~240 / 1 / 50
EER				3.09
COP				3.4
Piping Connection	Liquid		mm	ø 9.52
	Gas		mm	ø 22.2
	Drain	O.D./I.D.	mm	ø 32/25
Air Flow Rate		High/Medium/Low	m ³ /min	70.0 / 65.0 / 60.0
Sound Pressure	Cooling	High/Medium/Low	dBA	52/50/49
	Heating	High/Medium/Low	dBA	52/50/49
Sound Power	Cooling	Max	dBA	-
Dehumidification Rate			l/h	3.67
Dimensions	Body	WxHxD	mm	1,563 X 458 X 791
Net Weight	Body		kg	97
Supply Air Spigot		WxH	mm	1,044 X 286
Return Air Spigot		WxH	mm	1,368 X 392
Fan Motor Output			W	375 X 2
External Static Pressure-pre set		Min-Max	mmAq(Pa)	6.35~18.4(62~180)-180
Outdoor				B70AWYU83
Compressor	Type			INV Scroll
Airflow Rate		Nom	m ³ /min	190
Sound Pressure	Cooling	Nom	dBA	57
	Heating	Nom	dBA	57
Sound Power	Cooling	Max	dBA	78
Dimensions	WxHxD		mm	920 X 1,680 X 760
Net Weight			kg	181.0
Refrigerant	Type			R410A
	Charge		g	6,900
	Chargeless Piping Length (after 7.5m)		m	15
Operation Range (Outdoor)	Cooling	Min-Max	°C DB	-10 ~ 48
	Heating	Min-Max	°C WB	-15 ~ 24
Power Supply			V/ø/Hz	380~415 / 3 / 50
Power Supply Cable			N x mm ²	5 x2.5
Transmission Cable			N x mm ²	2 x1.0~1.5
Circuit Breaker			A	30
Piping Length Total		Max	m	100
Piping Elevation Difference	IDU-ODU	Max	m	30
Piping Connection	Liquid		mm	ø 9.52
	Gas		mm	ø 22.2

Note : 1. Due to our policy of innovation some specifications may be changed without notification.
2. Capacities are based on the in accordance with ASNZS3823.1.2
Cooling: - Indoor Temperature 27°C DB / 19°C WB Heating: - Indoor Temperature 20°C DB / 15°C WB
- Outdoor Temperature 35°C DB / 24°C WB - Outdoor Temperature 7°C DB / 6°C WB

Accessory







Central Control



Control Method	Objective/Use	Unit Name and Model	Function	Parts	Features
AC-EZ PQCSZ250S0	Provides a centralized point where up to 32 indoor units or indoor unit groups can be controlled and monitored		<ul style="list-style-type: none"> Remote control & Monitor 8 programmable schedules with mode and set point control Error code display during unit or system malfunction 	<ul style="list-style-type: none"> Controller Manual Screw 6EA Screw 4EA 	<ul style="list-style-type: none"> LED indicator for operating status Max 32 IDU control
AC Smart PQCSW320A1E	To control all indoor unit just like remote controller		<ul style="list-style-type: none"> Control/Monitoring Schedule History Auto control (Auto Changeover, temperature limit control) Setting Other setting Multi Language Emergency Stop Max 64 Indoor units 	<ul style="list-style-type: none"> AC Smart controller Power cord Manual 	<ul style="list-style-type: none"> Touch screen Zone/Group/Unit control Function Lock & Set Temp range restriction Icon/List View Easy upgrade by using USB
128 unit Expansion Kit PQCSE440U0	To expand control unit of AC Smart		<ul style="list-style-type: none"> To expand form 64 unit to 128 unit of AC Smart 	<ul style="list-style-type: none"> Expansion Kit Manual 	<ul style="list-style-type: none"> Shortly connect communication line to AC Smart, expand maximum control unit from 64 to 128 of AC Smart
AC-Smart Premium PQCSW421E0A	Provides a centralized point where up to 128 indoor units or indoor unit groups can be controlled and monitored		<ul style="list-style-type: none"> Visual navigation(structure mapping) Remote control & Monitor Web control Email error alarm 	<ul style="list-style-type: none"> Controller Manual 	<ul style="list-style-type: none"> 10.2 inch touch screen with user friendly GUI

Control Method	Objective/Use	Unit Name and Model	Function	Parts	Features
ACP PQCPC22N0 PQCPC22A0	To control all indoor unit just like remote controller		<ul style="list-style-type: none"> Control/Monitoring Schedule History Peak Power Control PDI Monitoring Setting Max 256 Indoor units Without IO (Install with AC Manager, Interlocking is impossible) 	<ul style="list-style-type: none"> ACP Power cord Manual 	<ul style="list-style-type: none"> Embedded web server (Can connected internet) Include Central Program in the ACP Web Server Directly IP Setting by using key & LCD Without DI/DO Port
AC Manager PQCSSA21E0	To control all indoor unit just like remote controller		<ul style="list-style-type: none"> Control/Monitoring Schedule History Peak Power Control Auto control (Auto Changeover, temperature limit control) Interlocking PDI data Manage Setting Max 8,192 Indoor units 	<ul style="list-style-type: none"> PC S/W(CD) Lock key Manual 	<ul style="list-style-type: none"> Install with several ACP supply more detail control & upgraded function Print & down with excel of all data Function Lock & Set Temp range restriction Icon/List View individual unit operating time manage Max 32 ACP connectable (Max 8,192 Indoors)

Accessory

Interface Device

Control Method	Objective/Use	Unit Name and Model	Function	Parts	Features
PI485 PMNFP14A0	To connect Outdoor unit to CNU or Simple Central Controller		<ul style="list-style-type: none"> • RS485 Converter with software • For Max.16 Indoor 	<ul style="list-style-type: none"> • PCB Assembly • Bracket • Lead wire: 3ea • Screw 4EA • Tie wrap • Clamp • Manual 	<ul style="list-style-type: none"> • 1set/1 Outdoor
Dry Contact PQDSA1/ PQDSB1	For connect Indoor unit to other Forced on/off Controller	 	<ul style="list-style-type: none"> • RS485 Converter with software 	<ul style="list-style-type: none"> • PCB Assembly • Top case • Bottom case • Screw • Lead wire 3 • Sub PCB set (1 leadwire + 1 sub PCB) • Manual 	<ul style="list-style-type: none"> • 1set/1 Indoor unit • PQDSB1 (24V) • PQDSA1 (24V)
Dry Contact PQDSBC*	For connect Indoor unit to other Forced on/off Controller	 	<ul style="list-style-type: none"> • Contact signal to air-con signal converter 	<ul style="list-style-type: none"> • PCB Assembly • Top/Bottom case • Screw • Lead wire 3ea • Sub PCB set (1 leadwire + 1 sub PCB) • Manual 	<ul style="list-style-type: none"> • 1set/1 indoor unit • 2 Contact points • No need AC input • Expected temperature setting is possible
BNU-LW PQNFB16A1	To connect PI485 to LONWORKS BMS system		<ul style="list-style-type: none"> • RS485 to LONWORKS Protocol Converter 	<ul style="list-style-type: none"> • Interface Assembly • 12V DC adaptor • Manual 	<ul style="list-style-type: none"> • 64 Indoor units / 1BNU-LW commission with Web Access can be install with simple central controller

Control Method	Objective/Use	Unit Name and Model	Function	Parts	Features
BNU-BAC PQNFB17B0	To connect PI485 to BACnet BMS system		<ul style="list-style-type: none"> • RS485 to BACnet protocol converter 	<ul style="list-style-type: none"> • Interface Assembly • 12V DC adaptor • Manual 	<ul style="list-style-type: none"> • 256 Indoor units / 1 BNU-BAC commission with Web Access can be install with simple central controller Directly IP Setting by using key & LCD
PDI PQNUD1S00	To Power consumption Distribution of each indoor unit		<ul style="list-style-type: none"> • Accumulation of total power consumption • Indication of current power in use • Indication of accumulated power for period • Indication of standby power (option setting) 	<ul style="list-style-type: none"> • PDI Assembly Manual 	<ul style="list-style-type: none"> • 1 PDI / 1 Outdoor
PDI Premium PQNUD1S40	To power consumption distribution of each indoor unit		<ul style="list-style-type: none"> • Accumulation of total power consumption • Indication of current power in use • Indication of accumulated power for period • Indication of standby power • Blackout protection 	<ul style="list-style-type: none"> • PDI Assembly manual 	<ul style="list-style-type: none"> • 1 PDI / 8 Outdoor

1) PI485 : Product Interface unit for RS 485 transmission

